

See discussions, stats, and author profiles for this publication at: <https://www.researchgate.net/publication/333447215>

Pressure build-up and wear analysis of tapered screw extruder biomass briquetting machines

Article · January 2019

CITATIONS

10

READS

1,193

3 authors:



Joseph I. Orisaleye

University of Lagos

40 PUBLICATIONS 250 CITATIONS

[SEE PROFILE](#)



S. J. Ojolo

University of Lagos

96 PUBLICATIONS 769 CITATIONS

[SEE PROFILE](#)



Js Ajiboye

University of Lagos

21 PUBLICATIONS 181 CITATIONS

[SEE PROFILE](#)

Some of the authors of this publication are also working on these related projects:



Machinery Optimization [View project](#)



EXPERIMENTAL PREDICTION AND OPTIMIZATION OF MATERIAL REMOVAL RATE DURING HARD TURNING OF AUSTENITIC 304L STAINLESS STEEL [View project](#)

Pressure build-up and wear analysis of tapered screw extruder biomass briquetting machines

Joseph Ifeolu Orisaleye^{*}, Sunday Joshua Ojolo, Joseph S. Ajiboye

(Mechanical Engineering Department, University of Lagos, P.M.B. 56, Akoka, Nigeria)

Abstract: The design of efficient screw extruder biomass briquetting machines is important for the utilization of loose biomass materials from wood and agricultural wastes for the production of solid fuel. In this study, the effects of geometrical parameters (channel depth and helix angle) and operational parameters (friction coefficient, mass flow rate and speed) on the performance and design of the briquetting machine were investigated using a pressure model based on the plug flow theory. An analytical model, which utilizes the pressure model, was also developed from Archard's wear law to investigate screw wear of biomass briquetting machines. The study on the pressure model showed that a shallow screw channel and small helix angle resulted in rapid pressure build-up along the screw extruder biomass briquetting machine. High friction at the barrel-material interface, low friction at the screw-material interface, high screw speed and high mass flow rate also resulted in rapid pressure build-up along the screw extruder biomass briquetting machine. The geometrical and operational parameters which resulted in rapid pressure build-up required shorter screw length for the briquetting machine. The wear model developed predicted the screw wear satisfactorily and showed that the screw speed and the choice of material for screw affected the screw wear. The wear volume increased exponentially towards the end of the screw where pressure is the highest. Redesigning the screw to select optimum geometry and speed with appropriate choice of material could improve the screw life and performance of the biomass briquetting machine.

Keywords: screw extruder, biomass briquetting machine, plug flow theory, Archard's wear law, pressure build-up

Citation: Orisaleye, J. I., S. J. Ojolo, and J. S. Ajiboye. 2019. Pressure build-up and wear analysis of tapered screw extruder biomass briquetting machines. *Agricultural Engineering International: CIGR Journal*, 21(1): 122–133.

1 Introduction

The densification of loose biomass materials is necessary for biomass logistics involving handling and transportation. Densification improves handling of biomass materials and also reduces the cost of transportation of biomass (Singh et al., 2010; Tumuluru et al., 2010). Densification also improves the fuel properties of biomass materials to give high energy density, hydrophobicity and good combustion properties. Technologies which have been developed for biomass densification include the piston presses, screw presses, roller presses and the pelleting machines. The screw press technologies are known to produce high quality briquettes

which are suitable for use in gasifiers and other combustion technologies (Tumuluru et al., 2010; Antwi-Boasiako and Acheampong, 2016). The screw press biomass briquetting machines work on the principle of extrusion with heated dies and do not require the use of binders.

However, the screw extruder biomass briquetting machine has problems of rapid screw wear and high power consumption. The rapid screw wear has been attributed to the high screw speed, which reaches up to 600 rpm (RERIC, 2003). Babu and Yuvaraj (2001) also stated that the problems of the screw press biomass briquetting machine are partly due to poor design. With respect to poor design of extruders, Gabrielle et al. (2001) and Talaška et al. (2016) opined that extruders need to be designed optimally before adaptation to new applications. Chen et al. (2009) also revealed that there is a considerable scope for design improvements which will lead to extended life of wearing parts and reduce energy

Received date: 2018-01-12 **Accepted date:** 2018-07-23

*** Corresponding author:** Joseph Ifeolu Orisaleye, Department of Mechanical Engineering, University of Lagos, Akoka, Nigeria. Email: ifeorisaleye@gmail.com.

consumption for briquetting of agro-residues.

Matúš and Križan (2012) have suggested that the movement of the material, the compression, the rate of wear and the stress distribution depend primarily on the chosen geometry of the screw. Tumuluru et al. (2010) also noted that there is a need to optimize the screw press briquetting machine to improve its performance.

Few studies have theoretically investigated the design of screw extruders for biomass briquetting with a view to improving its performance and design. Matúš et al. (2011) analysed the force on the screw of the briquetting machine with the aim to design new pressing screws to eliminate the problems of existing biomass briquetting machines. Wen et al. (2013) also investigated the force and motion of screw-type extrusion machines for biomass moulding and observed that the constriction region of the screw head was the region with the highest concentration of stress. The study suggested that due to the concentration of stress, the screw head was prone to rapid wear. It was suggested that the screw can be divided into two parts for easy replacement. Orisaleye and Ojolo (2017) also carried out a parametric study on a straight screw extruder for solids compaction investigating the effects of design parameters on the pressure developed in straight screws.

Theoretical investigations have recommended that tapered screws are preferred to the straight screws for biomass compaction due to higher pressure generated. Zhong (1991) investigated the compaction process in a tapered screw press theoretically and experimentally and observed that the measured pressures from experimental results agree with predicted pressures. Ojolo et al. (2015) also investigated the tapered screw using the plug flow theory and stated that the tapered screw generated higher pressures than the straight screw. The study also showed a procedure for determining the optimum taper angle of the screw extruder.

A few studies have investigated the screw wear of the screw extruder biomass briquetting machine despite being widely reported in previous researches (Wang and Zhao, 2014; Ghimire and Shrestha, 2014). Ghimire and Shrestha (2014) carried out experiments and determined the change in dimensions of the screw channel depth and flight thickness before and after use. They discovered that

the briquette screw wears out after four to five hours of production of briquettes.

Preheating of the biomass materials had been carried out to soften the feed before being fed into the screw extruder and this has enhanced screw life. It has been noted by RERIC (2003) that the quality of rice husk briquettes without pre-heating is generally better than that with pre-heating perhaps because pre-heating reduces the moisture content below the optimum requirement. Singh (2010) investigated different types of electrodes which were used in welding and hard facing of the screw while briquetting rice husk and concluded that tungsten carbide and austenitic electrodes can double the working hours of the screw.

Ali et al. (2004) and RERIC (2003) attributed the screw wear of the briquetting machine to the high speed of the screw and also to the abrasive nature of feed containing high silica materials. Theoretical study is yet to be carried out to investigate the wear of the screw of the biomass briquetting machine which would lead to proffering solutions to the screw wear.

The aim of this work is to develop a mathematical model to investigate the screw wear of the biomass briquetting machine.

2 Mathematical models

The mathematical models developed by Ojolo et al. (2015) were utilized in this study. The models are based on the understanding of the traction and retardation mechanism of friction for plug movement in screw extruders. The plug flow theory used in the development of the models considers two extremes of motion in a screw extruder. The first extreme involves the assumption that the screw is moving in the down-channel direction with the plug attached to it but the barrel is made stationary. The second extreme assumes that the plug is moving down-channel, attached to the barrel, but the screw is held stationary.

Other assumptions made in the development of the models include that the material flowing in the screw channel behaves as a solid plug; screw is always filled with material; Coulomb frictional conditions exist at the contact interfaces; the friction coefficients acting at contact surfaces are constant; effects of gravity,

centripetal and Coriolis acceleration are negligible; and pressures developed within the plug are non-isotropic. A schematic of the tapered screw is shown in Figure 1.

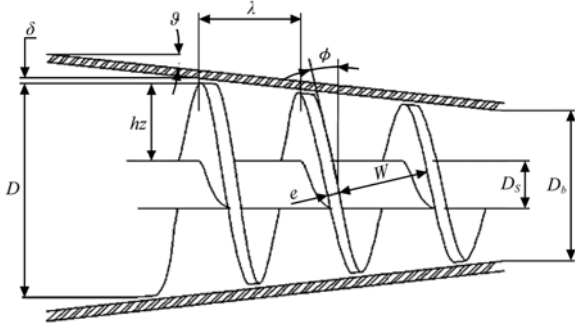

Figure 1 Schematic of the tapered screw with geometric description

2.1 Pressure model

The force diagram on an elemental slice flowing through the screw channel, shown in Figure 2, was obtained from the considerations of the traction and retardation mechanism described by Ojolo et al. (2015). Based on the force balance on the element, the pressure build-up along the tapered screw extruder biomass

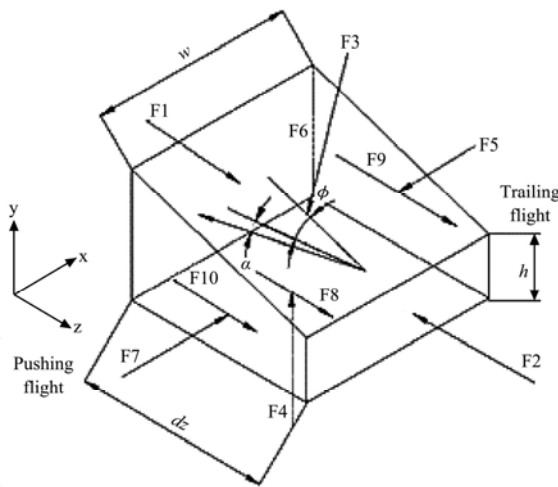

Figure 2 Forces acting on elemental slice of plug in inclined channel (Ojolo et al., 2015)

2.2 Required screw length

The maximum pressure P_{max} from Equation (1) is reached when $Z_s=L_s$. Therefore, the required screw length is expressed as (Ojolo et al. 2015):

$$L_s = \frac{h \sin \phi [1 - \mu_B \cos(\phi + \alpha) \tan \vartheta \sin \phi]}{\kappa \left\{ \mu_B \cos(\phi + \alpha) - \mu_S \left(1 + 2 \frac{\mu_f h}{\mu_S W} \right) - \mu_f \mu_B \sin(\phi + \alpha) + \tan \vartheta \sin \phi \left[1 + \mu_S \mu_B \left(1 + 2 \frac{\mu_f h}{\mu_S W} \right) \cos(\phi + \alpha) \right] \right\}} \ln \frac{P_{max}}{P_o} \tag{2}$$

Therefore, for a particular extrusion pressure, P_{max}

briquetting machine was determined. The pressure acting along the screw was obtained by integrating the differential pressure acting on the element over the length of screw channel. The model for pressure build-up is:

$$P_z = P_o \exp \left[\frac{\kappa Z_s}{h \sin \phi [1 - \mu_B \cos(\phi + \alpha) \tan \vartheta \sin \phi]} \left\{ \mu_B \cos(\phi + \alpha) - \mu_S \left(1 + 2 \frac{\mu_f h}{\mu_S W} \right) - \mu_f \mu_B \sin(\phi + \alpha) + \tan \vartheta \sin \phi \left[1 + \mu_S \mu_B \left(1 + 2 \frac{\mu_f h}{\mu_S W} \right) \cos(\phi + \alpha) \right] \right\} \right]$$

where, P_z is the pressure along the length of the screw in MPa; P_o is the pressure at the entry section into the screw beneath the hopper in MPa; κ is the stress transmission coefficient; Z_s is the distance along the length of the screw in mm; h is the channel depth in mm; w is the channel width in mm; ϕ is the helix angle; ϑ is the taper angle of the screw; α is the solids conveying angle; μ_B is the friction coefficient at the barrel interface; while μ_S and μ_f are the friction coefficients at the screw and flight respectively.

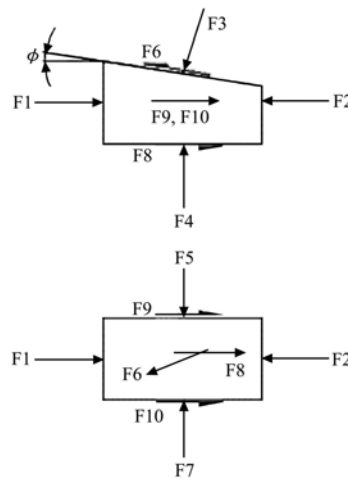

and specified geometrical and operational parameters, the minimum screw length, L_s , required for the screw extruder biomass briquetting machine can be determined from Equation (2).

2.3 Throughput model

From the velocity diagram of the plug flowing in the screw channel, shown in Figure 3, the volumetric flow rate was obtained as the product of the flow area and the velocity of the plug. The mass flow rate was obtained as the product of the density of material and the volumetric flow rate at the inlet. The expression for the mass flow rate is (Ojolo et al., 2015):

$$\dot{m} = 0.5\rho_o\pi^2[D_S + 2(h + \langle L_S - Z_S \rangle \tan \vartheta - \delta)][D_S + 2(h + \langle L_S - Z_S \rangle \tan \vartheta)]Nh \frac{\cos \vartheta \tan \alpha \tan \phi}{(\tan \alpha + \tan \phi)} \left[1 - \frac{e}{\pi[D_S + 2(h + \langle L_S - Z_S \rangle \tan \vartheta - \delta)] \sin \phi} \right] \quad (3)$$

where, ρ_o is the bulk density of material being processed by the screw; D_S is the screw root diameter in mm; N is the screw speed in rpm; L_S is the length of the screw in mm; Z_S is distance measured along the screw; e is the thickness of the screw flight in mm; and δ is the clearance between the screw flight and the barrel.

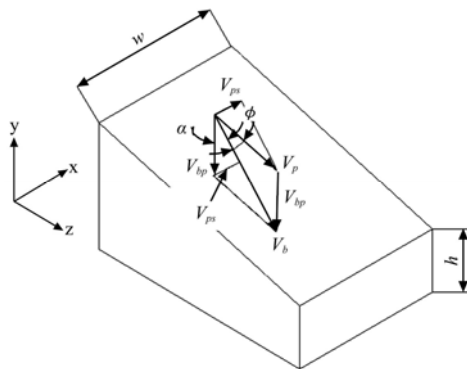

Figure 3 Velocities of the plug flowing through a tapered screw extruder channel (Ojolo et al., 2015)

Ojolo et al. (2015) stated that the density change of the biomass material in the screw channel should match the geometric change of the screw to prevent operational problems. Hence, the constant mass flow rate at the inlet and outlet was the basis for the determination of the optimum taper angle.

2.4 Solids conveying angle

Equations (1) and (3) are coupled by the solids conveying angle. Ojolo et al. (2015) assumed a fixed value for the solids conveying angle based on the study from Weert et al. (2001) which specified it to be less than 5°. However, for this study, the solids conveying angle can be determined from Equation (3) and substituted into Equation 1 to determine the pressure and into Equation (2) to determine the required screw length. The solids conveying angle is expressed as:

$$\alpha = \tan^{-1} \left\{ \frac{\dot{m} \tan \phi}{0.5\rho_o\pi^2[D_S + 2(h + \langle L_S - Z_S \rangle \tan \vartheta - \delta)] \times [D_S + 2(h + \langle L_S - Z_S \rangle \tan \vartheta)]Nh \cos \vartheta \tan \phi} \times \left[1 - \frac{e}{\pi[D_S + 2(h + \langle L_S - Z_S \rangle \tan \vartheta - \delta)] \sin \phi} \right] \right\} - \dot{m} \quad (4)$$

2.5 Wear analysis

The conventional Archard’s law of wear (Archard,

1953) is well-established and is commonly utilized in the study of wear at a macroscopic scale (Molinari et al., 2001; Juvinal and Marshek, 2012; Garleanu et al., 2008). Different mechanisms of wear, such as delamination, abrasion, adhesion and oxidation, can be described by Archard’s wear law (Flodin, 2000), but the wear of the screw in the briquetting machine is largely abrasive in nature (Singh, 2010). The Archard’s wear law of abrasion predicts the wear volume of an abraded material as a function of sliding distance in terms of a wear coefficient, the applied normal load and the material hardness (Siniawski et al., 2007).

From the Archard’s wear equation, the wear rate is:

$$\text{Wear rate} = \frac{\delta_w}{t} = \frac{K_w}{H_w} PV \quad (5)$$

From Equation (5), δ_w is the wear depth in m; t is the time in seconds; K_w is the dimensionless coefficient of wear; H_w is the surface hardness of the material in MPa; P is the surface interface pressure in MPa and V is the sliding velocity in m/s. An alternative form of the Archard’s wear law is:

$$W = \frac{K_w}{H_w} FS \quad (6)$$

From Equation (6), W is the volume of material worn away in m^3 ; F is the compressive force between the surfaces in N and S is the total rubbing distance in m. The compressive force term in Equation (6) can be expressed in terms of the pressure and the area of contact. The total rubbing distance can also be written in terms of the velocity and time such that Equation (6) becomes:

$$W = \frac{K_w}{H_w} PAVt \quad (7)$$

The area of flight normal to the radial pressure is the product of the flight thickness and the length of screw channel. The area of flight normal to radial pressure is expressed as (Orisaleye, 2016):

$$A = \frac{eL_S}{\sin \phi} \quad (8)$$

The volume of material worn away can, therefore, be expressed as:

$$W = \frac{K_w}{H_w} \frac{PeL_S Vt}{\sin \phi} \quad (9)$$

Given the number of flights, n , the screw length is n multiples of the screw pitch, λ , such that $L_S = n\lambda$. The wear

volume per pitch can then be written in terms of the screw pitch as:

$$\frac{W}{\lambda} = \frac{K_w}{H_w} \frac{PenVt}{\sin \phi} \quad (10)$$

The pressure build-up in the screw extruder biomass briquetting machine is expressed in Equation (1). Also, the velocity of the edge of the screw flight (πDN) can be substituted for the velocity term. This gives the volume of material worn per pitch as:

$$\frac{W}{\lambda} = \frac{\pi K_w \kappa e n D N t}{H_w \sin \phi} P_{\max} \exp \left[\frac{\kappa(n\lambda - L_s)}{h \sin \phi [1 - \mu_B \cos(\phi + \alpha) \tan \vartheta \sin \phi]} \cdot \left\{ \mu_B \cos(\phi + \alpha) - \mu_S \left(1 + 2 \frac{\mu_f h}{\mu_S w} \right) - \mu_f \mu_B \sin(\phi + \alpha) + \tan \vartheta \sin \phi \left[1 + \mu_S \mu_B \left(1 + 2 \frac{\mu_f h}{\mu_S w} \right) \cos(\phi + \alpha) \right] \right\} \right] \quad (11)$$

Equation (11) is used together with the solids conveying angle in Equation (4) to determine the wear depth profile of the screw.

4 Results and discussion

4.1 Effect of geometrical and operational parameters on pressure build-up

The effects of geometrical and operational parameters on the pressure build-up and screw design were

investigated using the presented models. The geometrical parameters considered were the channel depth and the helix angle. The operational parameters were the friction coefficients at the screw and barrel interfaces, the screw speed and the mass flow rate. The stress transmission coefficient was estimated, based on angle of internal friction of 45° , to be 0.17. Table 1 shows the parameters used in the investigation of the pressure build-up of the screw extruder biomass briquetting machine. The effects of geometrical and operational parameters on the pressure build-up in the screw extruder biomass briquetting machine is summarized in Table 2.

Table 1 Parameters used in the investigation of the pressure build-up in the screw extruder biomass briquetting machine

Parameter	Value
Taper angle, ϑ	2°
Screw root diameter, D_S	50 mm
Flight thickness, e	10 mm
Screw flight clearance from barrel, δ	5 mm
Pressure at the screw entry, P_o	0.1 MPa
Pressure at the screw exit, P_{\max}	150 MPa
Bulk density of biomass material, ρ_o	150 kg h^{-1}
Stress transmission coefficient, κ	0.17
Channel depth at end of screw, h	10-30 mm
Helix angle, ϕ	8° - 30°
Friction coefficient at barrel, μ_B	0.3-0.6
Friction coefficient at the screw, μ_S	0.1-0.25
Screw speed, N	200-600 rpm
Mass flow rate, \dot{m}	70 - 100 kg h^{-1}

Table 2 Effects of geometric and operational parameters on pressure build-up and required screw length

Parameter	Effect on pressure	Effect on required screw length
μ_B	High friction coefficient at the barrel interface results in a rapid pressure build-up in the screw extruder briquetting machine while the pressure build-up is slower when the friction coefficient at the barrel-biomass interface is lower.	A longer screw of specified channel geometry is required to attain a particular pressure at the exit of the screw when the friction coefficient is small but as the friction coefficient is increased, the required length of screw decreases.
μ_S	Pressure build-up is rapid when the friction coefficient is lower at the screw interface and much slower as the friction coefficient increases.	The required screw length for any pressure increases with increase in the friction coefficient at the screw surface.
h	The pressure build-up is rapid for a shallow screw channel than for a deeper channel.	For a specified pressure, the required length of the screw for the screw extruder briquetting machine increases with increase in the channel depth.
ϕ	The pressure build-up is rapid for a screw with a smaller helix angle, or narrow pitch, but slower with a wide-pitch screw which has a larger helix angle.	The required screw length for specified parameters increases with increase in the helix angle. There is a minimum helix angle below which the screw extruder briquetting machine will fail to operate properly.
N	The pressure build-up is more rapid for a screw operating at high speed than for a screw operating at a low speed.	A longer screw is required at a lower speed. The screw length decreases with an increase in the screw speed. It was observed that the required screw length is almost constant at very high screw speeds ($>250 \text{ rpm}$).
\dot{m}	There is a reduction in the pressure build-up along the screw length for an increased mass flow rate for a given screw configuration.	For specified parameters and pressure, the required screw length increases with increase in the mass flow rate.

4.1.1 Effect of friction coefficient at barrel

It is shown in Table 2 that high friction coefficient at the barrel interface is beneficial for high pressure applications such as the briquetting. In the field of polymer and food extrusion, grooves are machined on the

surface of barrels to achieve an increase in the pressure at the solids conveying zone of the screw extruders (Pan et al., 2012; Tadmor and Gogos, 2006) and also to prevent the plug of material in the solids conveying zone from rotating with the screw. Chung (2000) has also stated that

a high rubbing force at the barrel resulting from grooved barrel surface is a preferred condition for compaction and high conveying rate of solid bed. Rauwendaal (2001) stated that grooved feeding is used to improve feeding of low bulk density materials.

4.1.2 Effect of friction coefficient at screw-material interface

From Table 2, it is shown that for high pressure briquetting of biomass, low friction coefficient at the screw interface is required. Chung (2000) stated that low friction on the surface of the screw is a preferred condition for compaction. Polished screws are generally used in polymer processing (Tadmor and Gogos, 2006).

4.1.3 Effect of channel depth

As shown in Table 2, a screw extruder with shallow channel is required for biomass briquetting. However, caution should be taken in selection of the channel depth as the flow of material in the screw extruder can be hindered by excessively shallow channels.

4.1.4 Effect of helix angle

The helix angle determines the pitch of the screw with a large helix angle giving a wide pitch screw and vice versa. A smaller helix angle, or narrow pitch, is desired for high pressure densification of biomass. However, as highlighted for the channel depth, there is a minimum helix angle below which the screw extruder briquetting machine will fail to operate properly. A helix angle of about 17.66° is commonly used in standard screw extruders (Tadmor and Gogos, 2006). Studies from RERIC (2003) utilized a wide-pitch screw and a close-pitch screw and noted that the production capacity of a close-pitch screw was higher than for a wide-pitch screw. A close-pitch screw generates more pressure than a wide-pitch screw which will overcome the back pressure from the die constriction and result in higher productivity. The lower pressure build-up by the wider pitch screws with a larger helix angle will not easily overcome the constriction. In food extrusion, Yacu (2012) has stated screw pumping generally improves with reducing screw pitch and short pitch screws are used in the extruder metering section to generate necessary pressure in relatively short distance.

4.1.5 Effect of screw speed

High screw speeds are able to generate high pressures required during briquetting with the screw extruder.

Although, a high screw speed increases the pressure build-up, it reduces the screw life (RERIC, 2003). To generate sufficient pressure while maintaining a reduced speed, the screw length required would be increased. Studies from RERIC (2003) also showed that the production rate increases with an increase of screw speed. In relation to this work, if the production rate was fixed to a particular value which requires providing a higher restriction at the end of the screw, the result would be a higher pressure for a given screw length. A nearly constant screw length is required for the extruder at speeds greater than 250 rpm which is less than half of speeds reported by Tumuluru et al. (2010). Existing screw press briquetting machines use short screws which require high speeds. However, the alteration of screw length would reduce the required speed and could probably reduce the screw wear.

4.1.6 Effect of mass flow rate

The mass flow rate of the screw extruder can be varied by increasing or relaxing the restriction caused by the die constriction at the end of the screw. Relating findings from RERIC (2003) to this study, a greater constriction placed at the end of the screw will result in a decreased mass flow rate and a high pressure. Figure 4 shows a plot of the mass throughput and the pressure difference across the extruder. Since the pressure at the beginning of the screw is approximately that exerted by material in the hopper, it is seen that the throughput decreases with increase in the pressure of the extruder. The extruder characteristics from studies in polymer and food extrusion, which is a plot of the pressure difference with the throughput, show a similar trend (Tadmor and Gogos, 2006; Heldman and Lund, 2007; Rauwendaal, 1986).

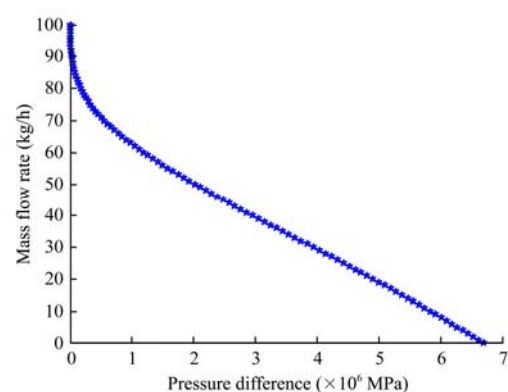

Figure 4 Plot of the mass flow rate with pressure difference of a tapered screw extruder biomass briquetting machine.

4.1.7 Comparison of models with other experimental studies

The models developed for the study of the pressure build-up in a screw extruder biomass briquetting machine are compared with experimental results from Zhong (1991). Whilst Zhong (1991) did not produce briquettes in his study, he determined the throughput of the tapered screw and the pressure build-up along the screw channel. The models were compared with the experimental data for sawdust which were provided in Zhong's study (1991). Figure 5(a) shows the plots for the pressure build-up when sawdust is processed at a speed of 70 rpm while Figure 5(b) shows the plots for the pressure build-up when sawdust is processed at a speed of 58 rpm. It is seen that the model fits quite well with the experimental results and the model predicts the trend of the pressure build-up along the screw. The pressure build-up when the screw rotates at 70 rpm is observed to be higher than when it operates at 58 rpm.

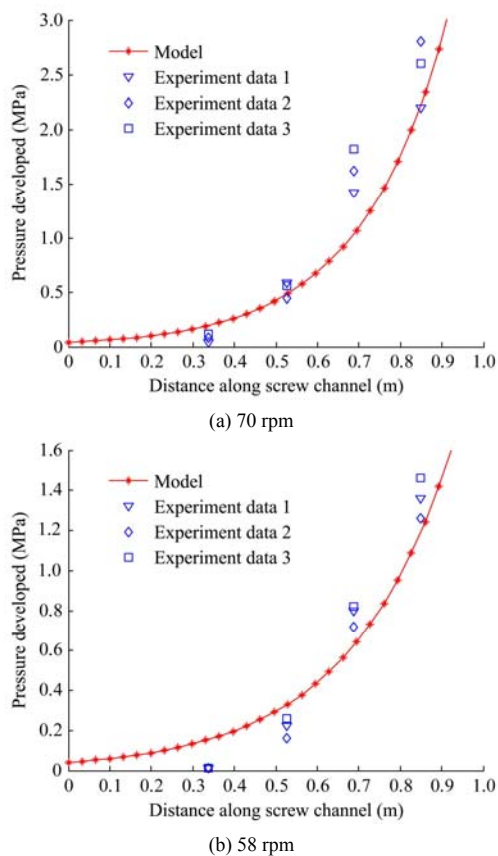

Figure 5 Plot comparing experimental data of pressure build-up along tapered screw from Zhong (1991) with current model for a screw speed of 60 rpm and 58 rpm

4.2 Investigation of wear of screw extruder briquetting machine

Figure 6 shows the plot which compares the results

obtained from the mathematical model with the experimental results from the study by Ghimire and Shrestha (2014). Juvinal and Marshek (2012) stated that the best way to obtain values of the wear coefficient K_w was from experimental data for the same combination of materials operating under essentially the same conditions. For simulation of the model, the wear coefficient was estimated to be 1.2×10^{-6} for an assumed hardness of 1500 MPa for low carbon steel. Low carbon steel is commonly used as the base metal for construction of briquetting screws.

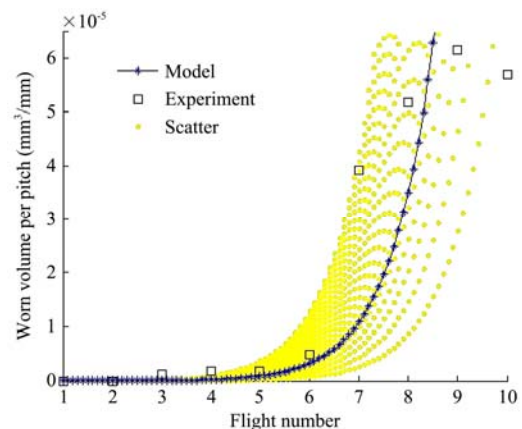

Figure 6 Comparison of the predicted screw wear of the briquetting machine from analytical model with experimental results from Ghimire and Shrestha (2014).

Figure 6 shows, in line with observations from Ghimire and Shrestha (2014), that the worn volume per pitch for a given combination of materials of screw and biomass depends on the position along the screw. This is because wear is dependent on the pressure which, as earlier shown, depends on the position along the screw extruder. Singh (2010) also stated that wearing takes place mainly at the first three flights of the screw where the pressure is highest.

Juvinal and Marshek (2012) stated that the wear coefficient is typically over a range of a quotient or product of four. Figure 6, therefore, shows the scatter plotted over the specified range. A good correlation ($r=0.67$) is, therefore, observed between the model and experiments as the experimental points fall within the scatter.

Apart from the wear rate of the screw being strongly dependent on pressure, the nature of material being processed is also important in determining the wear coefficient and consequently the wear rate. From

assertions by Ghimire and Shrestha (2014), the silica content in the biomass material determines the rate of wear with a higher silica content resulting in higher wear rates. Since rice husk had high silica content, it was mixed with other materials such as Sal leaves and sawdust which reportedly resulted in the extension of life of the screw.

The material of the screw is also an important consideration in design of screw extruder biomass briquetting machine. Most screws have been reported from literature to be made of mild steel and some part heat-treated by hard-facing using welding rods (Ali et al., 2004; Singh, 2013; Moral, 2000). Wang and Zhao (2014) proposed the use of ceramic wear resistant materials for the screw and stated that it had only one-tenth the wear of conventional alloys. There is yet to be a wide test using variety of materials for the screw and limited experimental data from screw extruder biomass briquettes as it regards wear. It had been noted that the reduction of the screw speed of a screw press briquetting machine resulted in an increase in the screw life (RERIC, 2003).

From the model developed, speed is seen to be an important factor. Considering the pressure model, the screw speed had been shown to be related to the minimum required screw length of the screw extruder biomass briquetting machine. Noting also that the existing machines have just two to three working flights embedded in the barrel or die, the screws can be said to be short screws. Figure 7 shows the effect of the reduction of screw speed on the worn volume per pitch of the screw considering the first three flights from the exit of the screw extruder. As observed, the worn volume per pitch reduces with a reduction in speed. From Table 2, it was stated that a shorter screw length requires the screw to rotate at a higher speed. Tumuluru et al. (2010) and RERIC (2003) have noted that the screw speeds of existing briquetting machines reach up to 600 rpm. It was observed that longer screws could operate at about one-third of the speeds of existing machines. Redesign of the screw extruder briquetting machines should, therefore, be explored alongside adequate choice of material of the screw and the modification of properties of biomass materials.

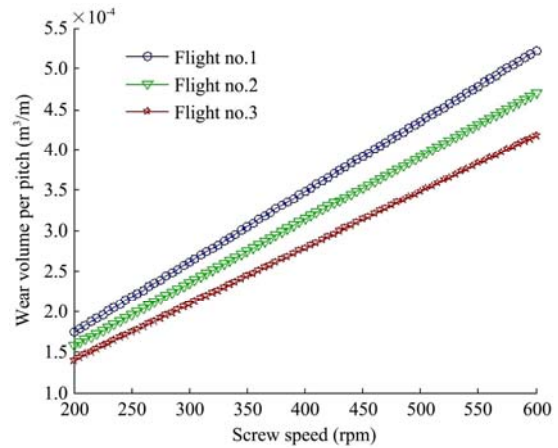

Figure 7 Relationship between the screw speed and wear volume of the screw extruder biomass briquetting machine for the first three flights from the briquetting die.

The choice of material for the screw of the biomass briquetting machine also contributes to the wear and screw life of the machine. Figure 8 shows the influence of the use of different materials for the screw on the worn volume of the screw along the length of the screw. Table 3 shows the influence of the use of different materials on the screw life of the biomass briquetting machine. Different materials have a range of wear coefficient as shown from the Ashby’s chart of normalized wear rate with hardness (Ashby, 2005). It is observed that materials with lower wear coefficient will give a better performance against wear. Ceramics appeared to give the best results in line with observations by Wang and Zhao (2014) who claimed that ceramic material used had only one-tenth of the wear of conventional alloys. As observed from Table 3, ceramics produce the highest screw life and could reach up to ten times the values obtained for alloy steels and tool steel in line with assertions made from experimental observations by Wang and Zhao (2014). From the results, it is obvious that redesigning the screw extruder with good choice of materials is essential for the improvement of screw life of the biomass briquetting machine.

Table 3 Screw life of the extruder for different materials of fabrication

Screw material	Screw life (hours)
Low carbon steels	1.6-4.2
Medium carbon steels	3.3-16.5
Stainless steels	3.6-16.5
Low alloy steels	10.9-65.9
Tool Steels	21.9-94.1
Ceramics	33.0-1099.5

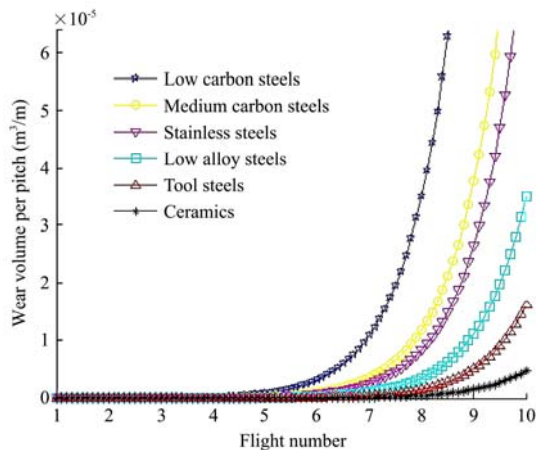

Figure 8 Influence of material of screw on the worn volume of the screw of a biomass briquetting machine

5 Conclusion

The screw extruder biomass briquetting machine has a high potential for the conversion of loose biomass materials from wood and agricultural wastes into solid fuel. The design of efficient screw extruder biomass briquetting machines is important to limit the existing problems of screw wear and power consumption. The effects of geometrical and operational parameters on the performance and design of the briquetting machine were investigated using a pressure model developed using the plug flow theory. The geometrical parameters considered were the screw channel depth and the helix angle. The operational parameters were the friction coefficient at the screw and barrel interfaces, screw speed and mass flow rate. The study showed that a shallow screw channel and small helix angle resulted in rapid pressure build-up along the screw extruder biomass briquetting machine. High friction at the barrel-material interface, low friction at the screw-material interface, high screw speed and reduced mass flow rate also increased the pressure build-up along the screw extruder biomass briquetting machine. The geometrical and operational parameters also determined the required screw length for the briquetting machine. The plug flow models predicted the trend of experimental data closely.

The wear of the screw of the biomass briquetting machine has also been investigated using a mathematical model developed from the Archard's abrasive wear law. The mathematical model predicted the wear of the screw within acceptable limits. It was shown, in line with experimental results, that the screw wear is highest at the screw end close to the die. High screw speeds were found

to increase the wear rate. The wear rate also depended on the material of the screw. The life of the screws of the biomass briquetting machines can be improved by redesigning the screw with appropriate selection of material. In addition, instead of the use of abrasive biomass materials, the use of composite materials comprising of a less abrasive material can be used to modify the wear coefficient at the interface of the screw and biomass material.

Appendix

The effect of the friction coefficient between the barrel and the biomass material on the pressure build-up in the screw extruder is shown in Figure A1(a). Figure A1(b) which shows how the length required for the screw extruder biomass briquetting machine decreases with increase in the friction coefficient at the interface between biomass and barrel.

The effect of the friction coefficient at the screw-material interface is shown in Figure A2(a). Figure A2(b), shows how the required screw length for different pressure increases with increase in the friction coefficient at the screw surface.

The effect of channel depth on the pressure build-up in the screw extruder biomass briquetting machine is shown in Figure A3(a). The effect of the channel depth in the determination of the required screw length is shown in Figure A3b.

Figure A4(a) shows the effect of helix angle on the pressure build-up in the screw extruder biomass briquetting machine. Figure A4(b) shows how the required screw length for a screw extruder biomass briquetting machine varies with the helix angle for specified design parameters.

The effect of the screw speed on pressure build-up in the screw extruder biomass briquetting machine is shown in Figure A5(a). For specified exit pressure and screw design parameters, the effect of screw speed on the choice of the required length of the screw extruder biomass briquetting machine is shown in Figure A5(b).

Figure A6(a) shows the effect of varying mass flow rate on the pressure build-up in the screw extruder biomass briquetting machine. Figure A6(b) shows the effect of the mass flow rate for given parameters and pressure on the design choice of length for the screw of the briquetting machine.

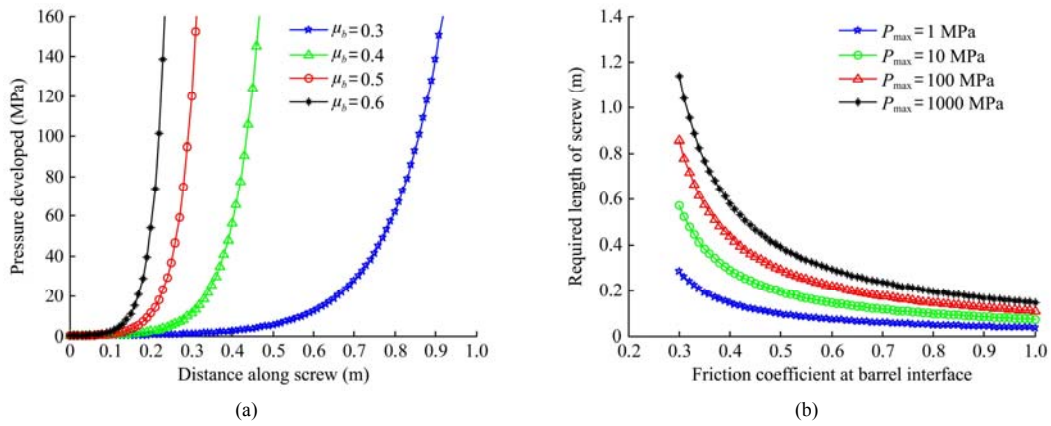

Figure A1 Effect of friction coefficient at the barrel-material interface on: (a) pressure build-up; (b) required screw length

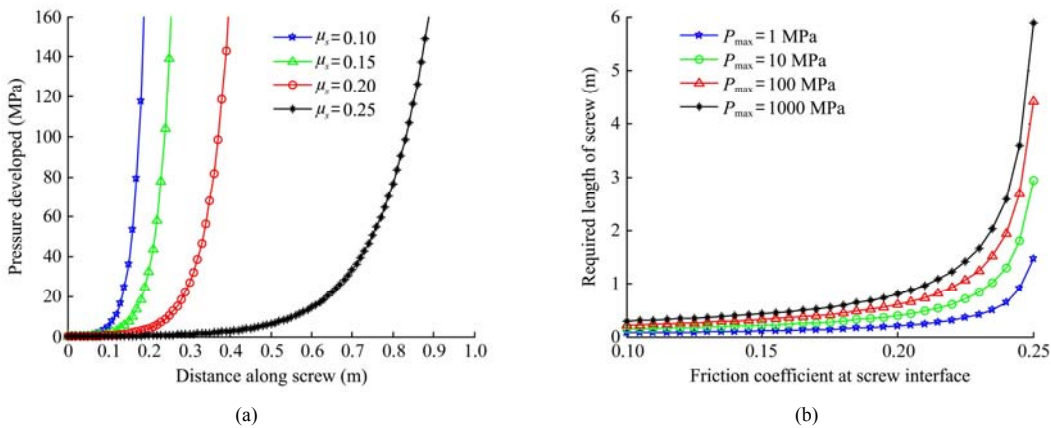

Figure A2 Effect of friction coefficient at the screw-material interface on: (a) pressure build-up; (b) required screw length

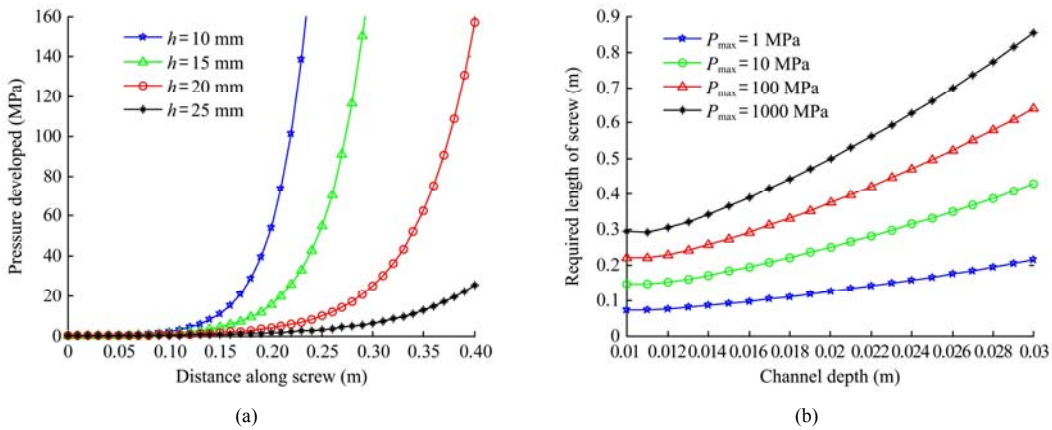

Figure A3 Effect of the channel depth on: (a) pressure build-up; (b) required screw length

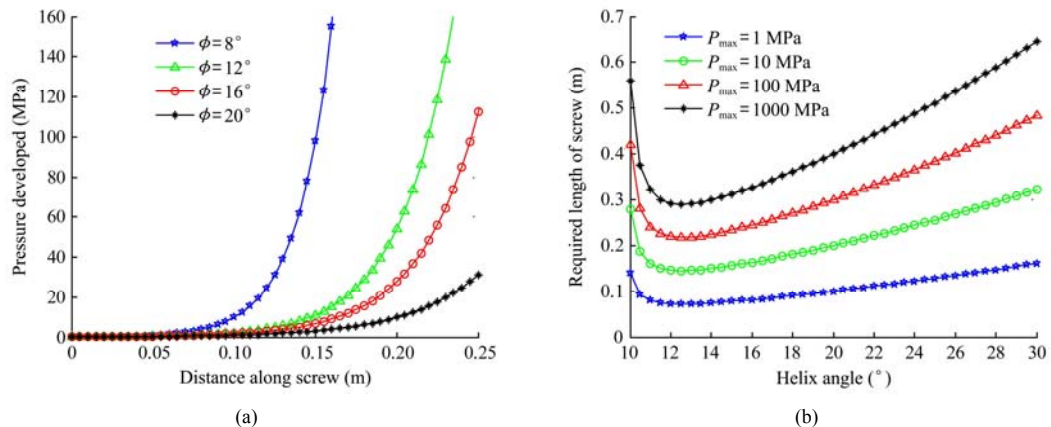

Figure A4 Effect of the helix angle on: (a) pressure build-up; (b) required screw length

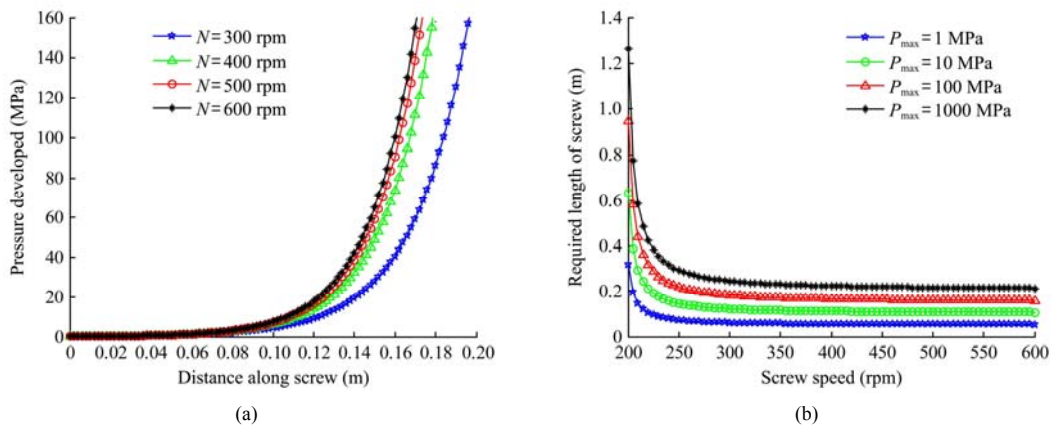

Figure A5 Effect of screw speed on: (a) pressure build-up; (b) required screw length

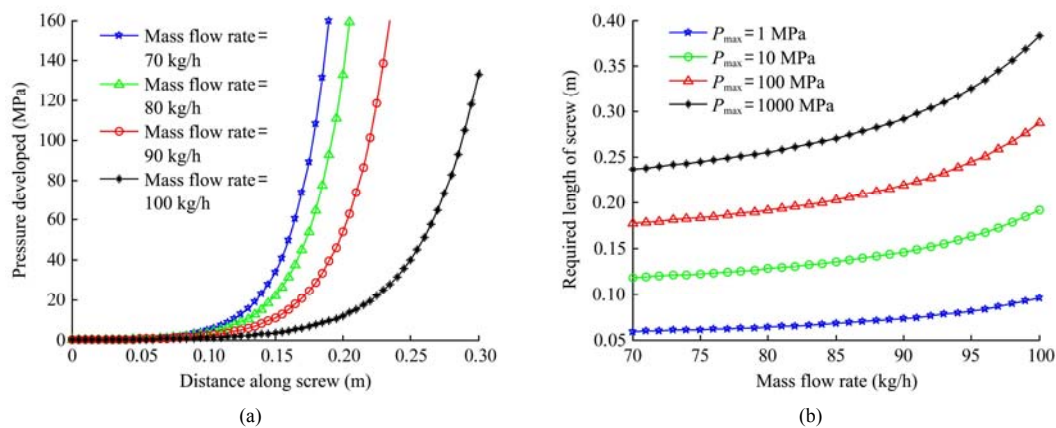

Figure A6 Effect of mass flow rate on: (a) pressure build-up; (b) required screw length

Notation

A	area of flight normal to radial pressure, mm^2
D_S	screw root diameter, mm
e	flight thickness, mm
F	compressive force between surfaces, N
h	channel/flight depth, mm
H_w	surface hardness, MPa
K_w	dimensionless wear coefficient
L_S	screw length, mm
\dot{m}	mass flow rate, kg h^{-1}
n	number of screw flights
N	screw speed, rpm
P	pressure, MPa
P_o	entry pressure, MPa
S	total rubbing distance, mm
t	time, s
V	sliding velocity, m s^{-1}
w	channel width, mm
W	wear volume, m^3
Z_S	distance along screw, mm
α	solids conveying angle, deg
δ	flight clearance, mm

δ_w	wear depth, mm
ϑ	screw taper angle, deg
κ	stress transmission coefficient
λ	screw pitch, m
μ_B	friction coefficient at barrel
μ_f	friction coefficient at flight
μ_S	friction coefficient at screw root
ρ_o	bulk density, kg m^{-3}
ϕ	helix angle of screw, deg

References

- Ali, M. N., M. M. Islam, C. Ferdous, and M. Refaul. 2004. Investigation for a suitable screw of a briquetting machine. In *Proc. Of the 2nd BSME-ASME International Conf. on Thermal Engineering*, 893-899. Dhaka, Bangladesh, 2-4 January.
- Antwi-Boasiako, C., and B. B. Acheampong. 2016. Strength properties and calorific values of sawdust-briquettes as wood-residue energy generation source from tropical hardwoods of different densities. *Biomass and Bioenergy*, 85: 144-152.
- Archard, J. 1953. Contact and rubbing of flat surfaces. *Journal of Applied Physics*, 24(8): 981-988.
- Ashby, M. F. 2005. *Materials Selection in Mechanical Design*. 3rd ed. Oxford: Elsevier.

- Babu, D., and N. Yuvaraj. 2001. Biomass densification-a solid (fuel) solution. TERI Newswire, 7. India: Energy and Resources Institute.
- Chen, L., L. Xing, and L. Han. 2009. Renewable energy from agro-residues in China: solid biofuels and biomass briquetting technology. *Renewable and Sustainable Energy Reviews*, 13(9): 2689–2695.
- Chung, C. I. 2000. *Extrusion of Polymers-Theory and Practice*. 2nd ed. Munich: Hanser Publishers.
- Flodin, A. 2000. Wear of spur and helical gears. Ph.D. diss., Stockholm: Royal Institute of Technology.
- Gabriele, D., S. Curcio, and B. de Cindio. 2001. Optimal design of a single-screw extruder for liquorice candy production: a rheology based approach. *Journal of Food Engineering*, 48(1): 33–44.
- Garleanu, D., V. Popovici, G. Garleanu, and M. Costoiu. 2008. Finite element analysis used for determination the endurance of surfaces. In *Proc. of the 1st WSEAS international conference on Visualization, imaging and simulation*, 151–154. Stevens Point, Wisconsin, USA: World Scientific and Engineering Academy and Society (WSEAS), 7–9 November.
- Ghimire, R. M., and R. Shrestha. 2014. Analysis for the financial viability of the rice husk briquette production by increasing screw life and reducing fuel cost. In *Proc. of IOE Graduate Conference*, 371–379. Kathmandu, Nepal, 10-11 October.
- Heldman, D. R., and D. B. Lund. 2007. *Handbook of Food Engineering*. 2nd ed. New York: Taylor and Francis.
- Juvinall, R. C., and K. M. Marshek. 2012. *Fundamentals of Machine Component Design*. 5th ed. New York: John Wiley and Sons Inc.
- Matúš, M., and P. Križan. 2012. Modularity of pressing tools for screw press producing solid biofuels. *Acta Polytechnica*, 52(3): 71–76.
- Matúš, M., P. Križan, J. Ondruška, and L. Šooš. 2011. Analysis of tool geometry for screw extrusion machines. *Aplimat-Journal of Applied Mathematics*, 4(2): 403–414.
- Molinari, J. F., M. Ortiz, R. Radovitzky, and E. A. Repetto. 2001. Finite-element modeling of dry sliding wear in metals. *Engineering Computations*, 18(3/4): 592–610.
- Moral, N. A. 2000. Briquetting of biomass in Bangladesh. In *Renewables: The Energy for the 21st Century, World renewable energy congress VI*, 2402-2405. Brighton, UK, 1-7 July.
- Ojolo, S. J., J. S. Ajiboye, and J. I. Orisaleye. 2015. Plug flow analysis of the compaction region of a tapered screw extruder biomass briquetting machine. *CIGR Journal*, 17(3): 176–195.
- Orisaleye, J. I. 2016. Analysis and design of a screw extruder biomass briquetting machine. PhD Research Seminar II Report. Nigeria: Mechanical Engineering Department, University of Lagos.
- Orisaleye, J. I., and S. J. Ojolo. 2017. Parametric analysis and design of straight screw extruder for solids compaction. *Journal of King Saud University - Engineering Sciences*, 31(1): 86–89.
- Pan, L., M. Jia, P. Xue, K. Wang, and Z. Jin. 2012. Studies on positive conveying in helically channel single screw extruders. *Express Polymer Letters*, 6(7): 543–560.
- Rauwendaal, C. 1986. *Polymer Extrusion*. New York: Hanser Publishers.
- Rauwendaal, C. 2001. Extrusion. In *Encyclopedia of Polymer Science and Technology*, 2, 497–558. John Wiley and Sons. doi:10.1002/0471440264.pst126
- Renewable Energy Resources Information Centre (RERIC). 2003. Renewable energy technologies in Asia. A regional research and dissemination programme – Phase II, Heated-die screw-press biomass briquetting machine: Design, construction and operation manual. Thailand: Renewable Energy Resources Information Centre (RERIC).
- Singh, J., B. S. Panesar, and S. K. Sharma. 2010. A mathematical model for transporting the biomass to biomass based power plant. *Biomass and Bioenergy*, 32(4): 483–488.
- Singh, R. M. 2010. Study on wearing of screw of biomass briquetting extruder. *Nepal Journal of Science and Technology*, 2(1): 83–86.
- Singh, R. M. 2013. Biobriquetting in Nepal – scope and potentials: a review. *Kathmandu University Journal of Science, Engineering and Technology*, 9(11): 104–120.
- Siniawski, M. T., S. J. Harris, and Q. Wang. 2007. A universal wear law for abrasion. *Wear*, 262(7-8): 883–888.
- Tadmor, Z., and C. G. Gogos. 2006. *Principles of Polymer Processing*. New Jersey: John Wiley and Sons.
- Talaška, K., I. Malujda, and D. Wilczyński. 2016. Agglomeration of natural fibrous materials in perpetual screw technique – a challenge for designer. *Procedia Engineering*, 136: 63–69.
- Tumuluru, J. S., C. T. Wright, K. L. Kenny, and J. R. Hess. 2010. A review on biomass densification technologies for energy application. IN/EXT-10-18420. Idaho: Idaho National Laboratory, U.S. Department of Energy.
- Wang, X., and X. Zhao. 2014. The application of ceramic wear resistant materials in biomass briquetting equipment. *Energy and Environment*, 25(5): 1003–1010.
- Weert, X., C. J. Lawrence, M. J. Adams, and B. J. Briscoe. 2001. Screw extrusion of food powders: prediction and performance. *Chemical Engineering Science*, 56(5): 1933–1949.
- Wen, B., L. Liu, S. Liu, K. Zheng, L. Hua, and S. Wang. 2013. Analysis and research of force and motion of screw-type extrusion molding biomass. *Advanced Materials Research*, 614-615: 452–459.
- Yacu, W. A. 2012. Extruder selection, design, and operation for different food applications. In *Advances in Food Extrusion Technology*, eds. M. Maskan and A. Altan, ch. 2, 23–68. London: CRC Press.
- Zhong, Z. 1991. Theoretical and experimental analysis of the compaction process in a tapered screw press. Ph.D. diss., England, UK: The University of Newcastle.