



CONTROL OF PARTICULATE MATTER (PM) EMISSIONS FROM INDUSTRIAL PLANT USING ANFIS BASED CONTROLLER

Sambo A. Umar^{1,2}, Adamu Y. Babawuro^{1,2}, Momoh Jimoh E. Salami¹ and Md. Raisuddin Khan¹

¹Department of Mechatronics Engineering, Kulliyah of Engineering, International Islamic University, Malaysia

²Department of Mechatronics and Systems Engineering, Faculty of Engineering, Abubakar Tafawa Balewa University (ATBU), Bauchi, Bauchi State, Nigeria

ABSTRACT

In recent times, the negative effect of air pollution such as particulate matter (PM) emitted from industrial plants has compelled researchers in finding efficient control system to control such pollutants in order to keep the environment safe. The aim of this study is to develop a reliable method of controlling the emissions of PM using wet scrubber system as a control device. The process of a wet scrubber is nonlinear in nature. Due to difficulty in selecting optimum scrubbing liquid droplet size in wet scrubbing process, the system becomes complex. Thus, Adaptive Neuro Fuzzy Inference System (ANFIS) based control technique is employed in this paper to handle the nonlinearities. ANFIS control technique has the advantage to integrate fuzzy logic systems and learning ability of neural network, thus able to handle nonlinear systems better. The controller is developed using data of PM emission from cement kiln. The system is simulated using triangular and trapezoidal membership function (MF) with 2 and 3 input MF in each case. The performance of the controller is evaluated based on settling time. The results indicated that the developed controller was able to maintain the PM emission below a set point of $20\mu\text{g}/\text{m}^3$ which is the maximum allowable PM emission limit recommended by world health organization (WHO). The controller with 2 input triangular membership functions indicated a better performance with a settling time of 5.2 seconds.

Keywords: air pollution, industrial plant, PM emission, wet scrubber system, control, ANFIS.

INTRODUCTION

Studies indicated that PM gains greater attention in the field of air pollution control among other types of pollutants. PM is a mixture of tiny solid particles and liquid droplets found in air. These tiny particles appear in different sizes and shapes and can be made up of thousands of different chemicals. The Particles are categorized as PM, PM₁₀, PM_{2.5} and PM_{1.0} by size with mass median aerodynamic diameter less than 100 μm , 10 μm , 2.5 μm and 1 μm respectively [1].

Literatures shows that, PM₁₀ portion amounted to more than 90% of total PM emission from industries while PM_{2.5} portions are between 50% and 90% and PM_{1.0} constituted between 20% and 60% [2]. Exposure to these particles can lead to serious health effects, such as cancer, lung disease, cardiovascular disease, cystic fibrosis, asthma, pneumonia to mention a few [3]. Furthermore, it also causes damage to other living organisms, and also affects the natural environment. Due to the growing effects of PM emission, environmental concerned agencies such as Environmental Protection Agency (EPA) and World Health Organization (WHO) enforced laws on maximum PM emission limit [4]. As a result of this, researchers' attention was driven into finding efficient control systems or techniques, which are cost effective, simple, and have high performances in removing these fine particles from industrial plants.

The common air pollution control devices (systems) used in industries such as power plants, steel mills, cement plants, refineries, etc. to control the emission of PM, vapours, aerosols, or gases are wet scrubbers, dry

scrubbers, electrostatic precipitators, fabric filters (backhouse) and cyclone separators [5, 6]. Among these systems, wet scrubbers are advantageous because they are effective for controlling the emission of both PM and gas pollutants [7, 8]. They are also less expensive in design and simpler than other particle control devices, thus can be used in small and medium scale industries for scrubbing to PM and gaseous pollutants [9, 10].

The scrubbing process to separate the particles from gas is done by spraying a liquid into the gas stream or passing the gas stream through the liquid solution. As the gas stream contacts the liquid, the liquid droplets provide a blanketing effect to entrap the particles contaminants within the wet scrubber system.

Wet scrubbers are of different types but the most common once are spray towers scrubber, cyclone spray towers, tray towers, venturi scrubbers, orifice scrubbers, condensation scrubbers, packed towers and dynamic scrubbers [11]. According to [6], spray towers are the most effective for controlling the emission of cement dust particles which is the case in this study.

Cement is a commodity that is widely used in today's life. The demand increases over time as the population of the world increases. As a result, the cement dust contaminants are easily found in our environments and they can be easily inhaled. Thus, there is a need to control the emission of its particles because they fall within the category of PM, PM₁₀ and PM_{2.5}.

Several attempts have been presented in literatures to improve the efficiency of scrubbing in wet scrubber system for the effective control of PM₁₀ and



PM_{2.5} which are the most dangerous, for instance in [7, 12-14]. The studies basically concerned on predicting the performance efficiency of the system. However, this study employed intelligent control technique based on ANFIS to control the emission of PM₁₀ and PM_{2.5} in vertical spray tower wet scrubber system.

ANFIS is powerful tool used in control systems. It combines the advantage of fuzzy logic control (FLC) and artificial neural network (ANN). According to [15], ANN has strong learning capabilities at the numerical level. Fuzzy logic has a good capability of interpretability and can also integrate expert's knowledge. The hybridization of both paradigms yields the capabilities of learning, good interpretation and incorporating prior knowledge. Research conducted by [16] indicated that ANFIS controllers improves system performance in terms of time domain specification, set point tracking, disturbance rejection with optimal stability. ANFIS uses a hybrid-learning algorithm that combines the back propagation learning to determine the parameters related to membership functions and least squares methods to create a fuzzy inference system whose membership functions are iteratively adjusted according to a given input and output data pairs. ANFIS implement a Takagi-Sugeno Fuzzy Inference System (FIS).

PROPOSED SYSTEM

The schematic diagram of wet scrubber system with the proposed ANFIS controller is shown in Figure-1. From [17], the concentration of the PM at the scrubber exit y_b has a model as described by Equation (1). The value can be measured using a dust sensor. Once it exceeds the set point (y_{ref}) of 20 $\mu\text{g}/\text{m}^3$, the controller suggests an optimum liquid droplet size (d_D) for effective scrubbing. The liquid droplets flowing downward from a spray nozzle in the system counteract with the PM dust flowing upward, thus the optimum liquid droplet provides a

blanketing effect to entrap the particles contaminants and drained them down as slurry.

$$y_d = y_p \exp \left\{ -\frac{3}{2} \frac{Q_L}{Q_G} \frac{v_r}{v_r - v_g} \frac{z}{d_D} \eta_{sep} \right\} \quad (1)$$

From the model, y_p , Q_L/Q_G , v_g , v_r , z and η_{sep} are the inlet PM concentration ($\mu\text{g}/\text{m}^3$), liquid to gas ratio, gas velocity (m/s), relative velocity of gas and liquid (m/s), scrubber height (m) and gas-particle separation efficiency respectively. The gas-particle separation efficiency depends on the particle size. The particle size affects the concentration of the contaminants and it is considered as a disturbance variable.

The aim of the proposed controller is to manipulate the scrubbing liquid based on the concentration level of the PM contaminants so as to maintain the emission of PM below the maximum allowable limit by WHO despite the random changes in the PM concentrations caused by the disturbance variable.

ANFIS CONTROLLER DEVELOPMENT

This section describes the development of the proposed ANFIS controller for the wet scrubber system so as to maintain the output PM concentration below the set point value. The development of the controller involves the steps described in Figure-2.

Particle sizes ranges from 0.1 μm - 10 μm (PM_{2.5} and PM₁₀) serves as the first input data which are generated randomly. They are generated randomly because the sizes of the dust particles emitted in industrial plants also changes randomly and it serves a disturbance to the system. The cement dust particle sizes and concentrations adopted from [11] is used to developed a curve fit model which gives the relationship between particle size, p_D and concentration, y_p as given in Equation (2).

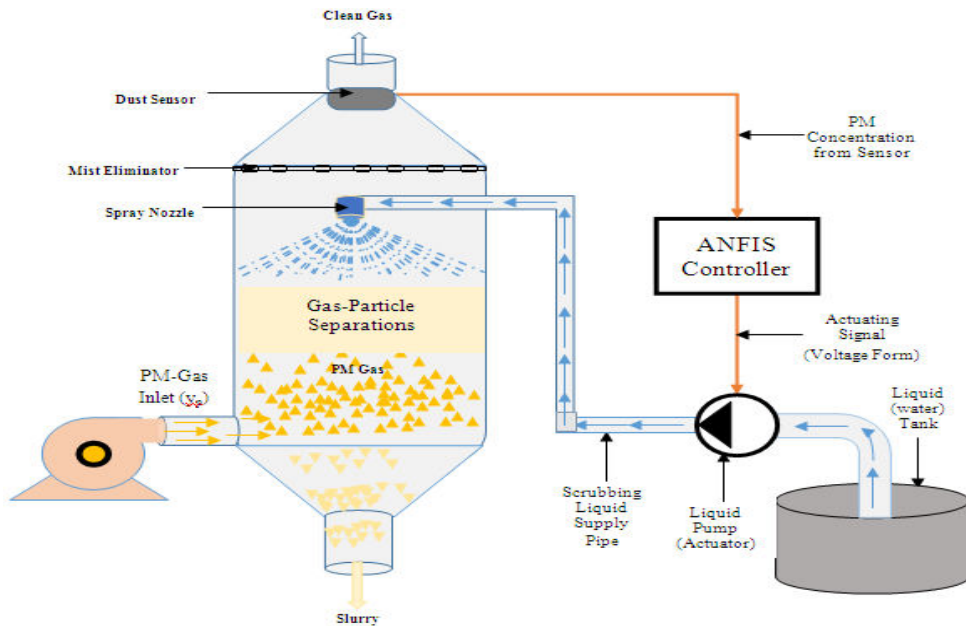

Figure-1. Schematic diagram of spray tower wet scrubber system.

$$y_p = 11010p_D^4 - 127200p_D^3 + 532000p_D^2 - 927000p_D + 667000 \tag{2}$$

The y_p data obtained from this model serves as the second input data to the controller as shown in Figure-3. As the particle sizes changes randomly, the required scrubbing liquid sizes (controller output) should also change randomly so as to efficiently scrub the contaminants. Thus, the data (droplet size) is also generated randomly from 19.5 μm -54 μm [11]. This range of droplet size is the minimum and maximum that can be obtained from a Hago nozzle considered in this study.

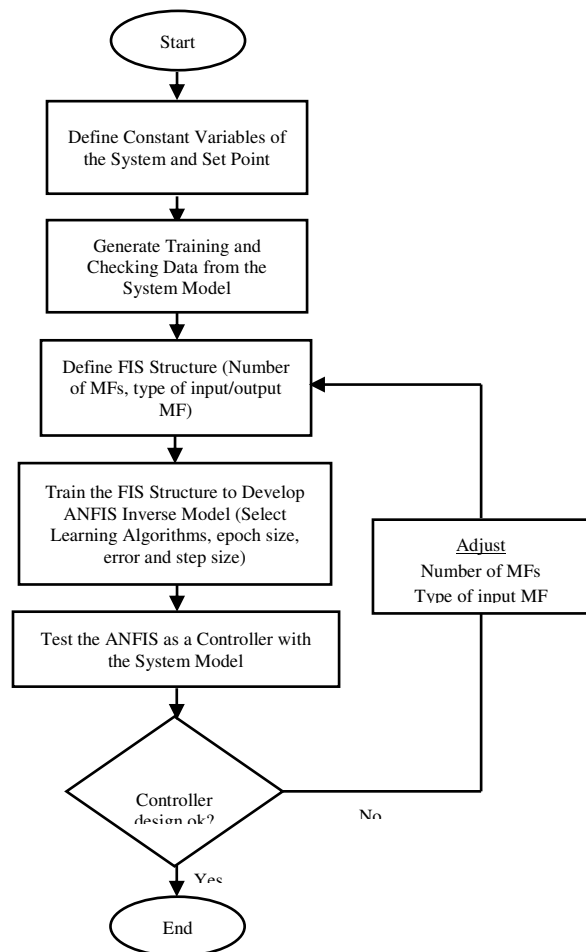

Figure-2. Flowchart for ANFIS controller development.

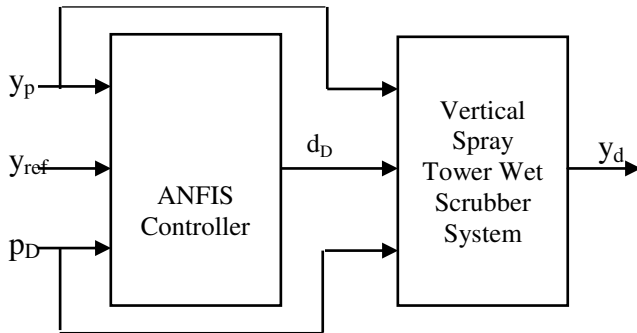

Figure-3. Block diagram of the controller and the system.

A set of 150 input/output data are generated. The data is divided into training data and checking data. The number of training data points should be several times greater than the number of parameters being estimated [18]. Thus, the first 100 data is used for training while the remaining is used as checking data.

After generating the data, the next thing in ANFIS modelling is to define the ANFIS structure and set the initial parameters for learning. To generate ANFIS structure, either *genfis1* () or *genfis2* () function is used. [19] recommended *genfis1* because the system has only one output and thus it's used in this work. *genfis1* () generates a Sugeno-type FIS structure from training data using grid partition on the data without applying clustering. The input MFs considered is Triangular and Trapezoidal while a default type of output MF (linear output MF) is used. The numbers of MFs selected for simulation are 2 and 3 in each case.

Once the data are generated and the ANFIS structure is obtained, then the ANFIS is trained to learn the inverse of the plant model so that it can serve as a controller. In training the FIS, either back propagation or hybrid (combination of least square and gradient descent) is used. In this design, the hybrid method is used because it converges faster by reducing search space dimensions. Another important parameter in the FIS training is the error tolerance which should approach zero. A 0.00001 is chosen as the error tolerance with a default step size of 0.01. The learning will continue until a maximum epoch is reached. The number of epoch chosen for this design is 50 because it is noticed that no significant change in error was observed after 50 epoch. After successful training of the FIS, it is used as a controller for the proposed system.

RESULTS AND DISCUSSIONS

The results of the developed ANFIS controller with 2 and 3 input trapezoidal MFs are presented in Figure-3 and Figure-4 while that of 2 and 3 input triangular MF are shown in Figure-5 and Figure-6 respectively.

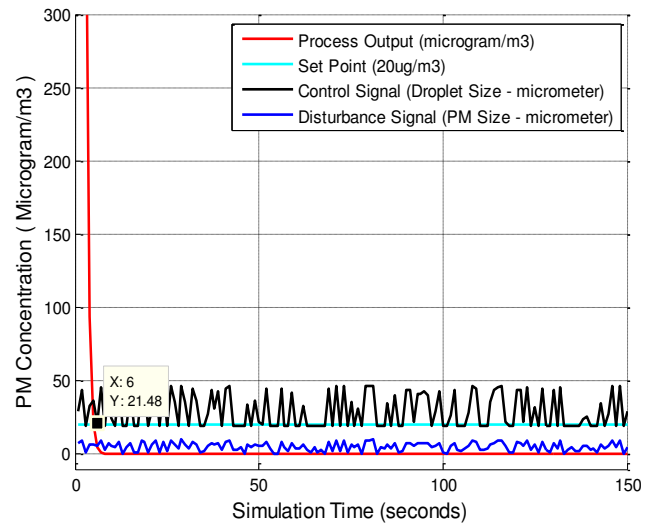

Figure-3. ANFIS control response for 2 inputs trapezoidal MF.

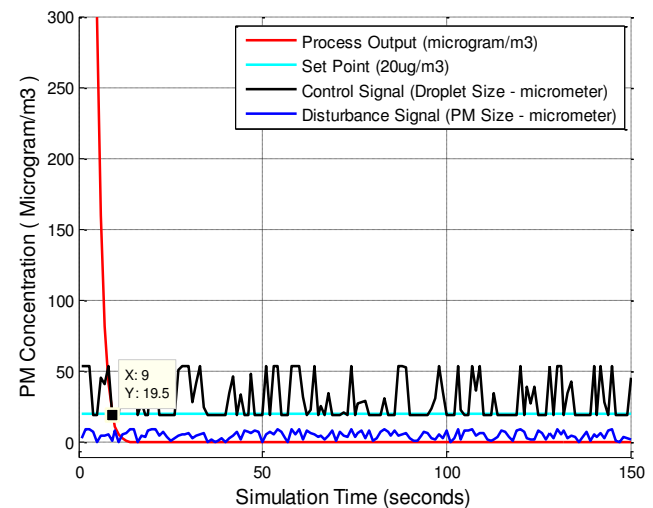

Figure-4. ANFIS control response for 3 inputs trapezoidal MF.

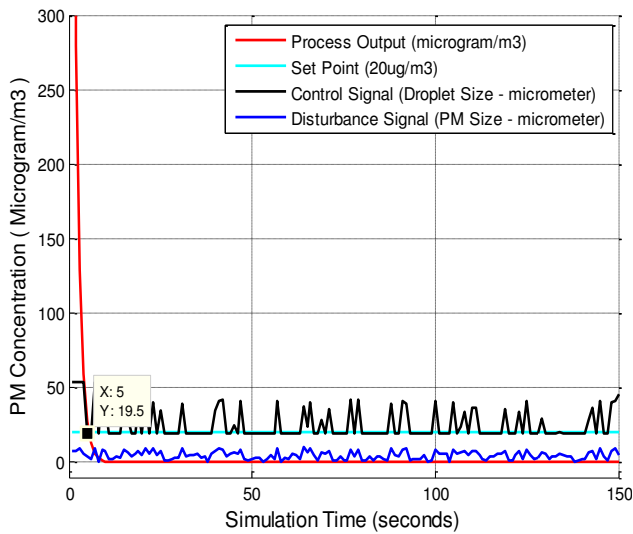

Figure-5. ANFIS control response with 2 inputs triangular MF.

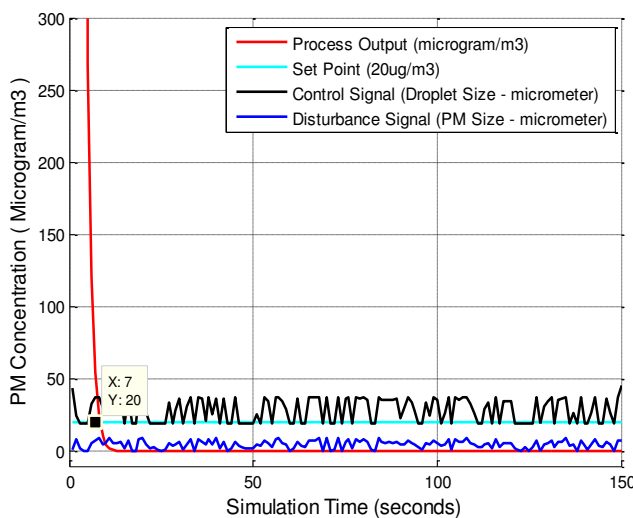

Figure-6. ANFIS control response with 3 inputs triangular MF.

It has been noticed that increased in the number of MFs increases the simulation time as well. Although more MFs which lead to more rules will give more information about the system, thus may improve the precision and control performance.

From the results obtained, in both cases (triangular and trapezoidal MFs) the controller was able to suggest an optimum droplet size to maintain the process output (PM concentration) below the set point value despite the disturbances caused by changes in particle sizes. Table-1 shows the settling time for each simulation result obtained. Controller developed with 2 triangular MFs indicated a better control objective with a settling time of 5.2 seconds. In most studies, usually triangular MF gives better result compared to other types of MFs for instance in [20, 21].

Table-1. Performance evaluation of developed controller.

MF type	Number of input MF	Type of output mf	Settling time (seconds)
Trapezoidal (trapmf)	2	Linear	5.5
	3	Linear	9.2
Triangular (trimf)	2	Linear	5.2
	3	Linear	7.0

CONCLUSION

This study described the development of intelligent control technique based on ANFIS for controlling the emission of PM contaminants (cement dust) from industries using wet scrubbing process. The controller is developed using triangular and trapezoidal membership function. The number of input membership function considered for both trapezoidal and triangular are 2 and 3 with linear output. The controller performance is evaluated based on settling time and the results indicated that the controller was able to suggest optimum scrubbing liquid size to maintain the emissions of cement dust contaminants below the set point of $20\mu\text{g}/\text{m}^3$ recommended by world health organization. ANFIS controller developed with two triangular membership functions indicated a smaller settling time of 5.2 seconds.

REFERENCES

- [1] S. Tiwari, D. Chate, P. Pragya, K. Ali, and D. S. Bisht, Variations in Mass of the PM10, PM2.5 and PM1 during the Monsoon and the winter at New Delhi, Aerosol and Air Quality Research. vol. 12, pp. 20-29, 2012.
- [2] C. Ehrlich, G. Noll, W.-D. Kalkoff, G. Baumbach, and A. Dreiseidler, PM 10, PM 2.5 and PM 1.0-Emissions from industrial plants-Results from measurement programmes in Germany, Atmospheric Environment. vol. 41, pp. 6236-6254, 2007.
- [3] T. Godish and J. S. Fu, Air quality: Book Section: CRC Press. 2003.
- [4] B. R. Mohan, R. Jain, and B. Meikap, Comprehensive analysis for prediction of dust removal efficiency using twin-fluid atomization in a spray scrubber, Separation and Purification Technology. vol. 63, pp. 269-277, 2008.
- [5] F. R. Spellman and N. E. Whiting, Environmental engineer's mathematics handbook: CRC Press. 2004.
- [6] B. A. Danzomo, M.-J. E. Salami, M. R. Sani Jibrin, and I. M. Nor, Performance Evaluation of Wet



www.arpnjournals.com

- Scrubber System for Industrial Air Pollution Control. 2012.
- [7] P. Keshavarz, Y. Bozorgi, J. Fathikalajahi, and M. Taheri, Prediction of the spray scrubbers' performance in the gaseous and particulate scrubbing processes, *Chemical Engineering Journal*. vol. 140, pp. 22-31, 2008.
- [8] B. R. Mohan, S. Biswas, and B. Meikap, Performance characteristics of the particulates scrubbing in a counter-current spray-column, *Separation and Purification Technology*. vol. 61, pp. 96-102, 2008.
- [9] J. C. Chang and S. B. Ghorishi, Simulation and evaluation of elemental mercury concentration increase in flue gas across a wet scrubber, *Environmental science and technology*. vol. 37, pp. 5763-5766, 2003.
- [10] K.-I. Choi and D.-H. Lee, PCDD/DF concentrations at the inlets and outlets of wet scrubbers in Korean waste incinerators, *Chemosphere*. vol. 66, pp. 370-376, 2007.
- [11] B. A. Danzomo, Intelligent control of wet scrubber system for Gas-Particle separations Ph.D., *Mechtronics Engineering, International Islamic University, Malaysia*. 2014.
- [12] Y. Bozorgi, P. Keshavarz, M. Taheri, and J. Fathikalajahi, Simulation of a spray scrubber performance with Eulerian/Lagrangian approach in the aerosol removing process, *Journal of hazardous materials*. vol. 137, pp. 509-517, 2006.
- [13] S.-H. Park and B.-K. Lee, Development and application of a novel swirl cyclone scrubber: (2) Theoretical, *Journal of hazardous materials*. vol. 164, pp. 315-321, 2009.
- [14] B. A. Danzomo, M.-J. E. Salami, and M. R. Khan, Artificial Neural Network Model for Predicting Wet Scrubber Performance, *International Journal of Scientific and Engineering Research*. vol. 3, pp. 1-10, 2012.
- [15] J.-S. Jang, ANFIS: adaptive-network-based fuzzy inference system, *Systems, Man and Cybernetics, IEEE Transactions on*. vol. 23, pp. 665-685, 1993.
- [16] S. Ravi, M. Sudha, and P. Balakrishnan, Design of intelligent self-tuning GA ANFIS temperature controller for plastic extrusion system, *Modelling and Simulation in Engineering*. vol. 2011, p. 12, 2011.
- [17] S. A. Umar, A. Y. Babawuro, F. Sado, M. J. E. Salami, and M. R. Khan, Fuzzy Logic Controller (FLC) for the Control of Particulate Matter (PM) Emission in Wet Scrubber System, *International Conference on Computer, Electrical and Electronics*. pp. 131-138, 2015.
- [18] N. Siddique and H. Adeli, *Computational intelligence: synergies of fuzzy logic, neural networks and evolutionary computing*: John Wiley and Sons. 2013.
- [19] B. A. Danzomo, M. J. E. Salami, and M. Khan, Hardware Implementation of ANFIS Controller for Gas-Particle Separations in Wet Scrubber System, in *Computer and Communication Engineering (ICCCE), 2014 International Conference on*. 2014, pp. 277-280.
- [20] Z. Yunusa, A. Dan-Isa, Y. A. Sai'd, and R. Shoorangiz, Effects of the number of rules on the quality of fuzzy logic control of induction motor, *International Journal of Applied Electronics in Physics & Robotics*. vol. 1, pp. 14-17, 2013.
- [21] J. G. Monicka, N. G. Sekhar, and K. R. Kumar, Performance evaluation of membership functions on fuzzy logic controlled ac voltage controller for speed control of induction motor drive, *International Journal of Computer Applications*. vol. 13, pp. 8-12, 2011.